

Finish (Part Number)

Size	Mill	Bronze	White
Flush *	L-5500	L-5583	L-5608
1/16" *	L-5501	L-5584	L-5609
1/8" *	L-5502	L-5585	L-5610
3/16" *	L-5549	L-5586	L-5611
1/4" *	L-5550	L-5587	L-5612
5/16" **	L-5503	L-5588	L-5613
3/8" **	L-5504	L-5589	L-5614
7/16" **	L-5505	L-5590	L-5615
1-3/16" **	L-5606	L-5607	L-5616

*No. 8 Phillips pan head sheet metal screws.
 **No. 10-24 Phillips pan head machine screws.

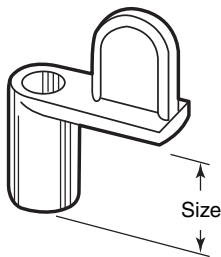

**Special
For Hawaii**

L-5557

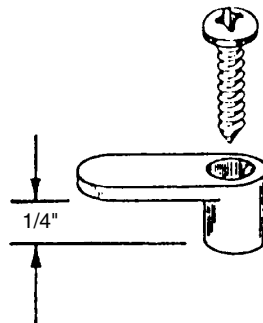

Diecast Clips

Contents: 12 clips with installation screws.

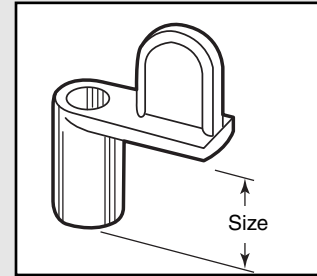

Description: Painted and plated clips used to attach screen to window opening.

NOTE: Also available in bulk (1000/ctn.)
Almond & Adobe available in bulk only.

Diecast Clips (Special)

Contents: 12 clips with #8 x 1" Phillips pan head sheet metal screws.

Finish (Part Number)

Size	Mill	Bronze	White
5/16"	L-5665	L-5668	L-5674
3/8"	L-5666	L-5669	L-5675
7/16"	L-5667	L-5670	L-5676

Description: Painted and plated clips; supplied with 1" long sheet metal screws for Hawaii installations.

L-5557 (1/4")

Diecast Clips

Contents: 12 clips with #8 x 3/4" Phillips pan head sheet metal screws.

Description: Flat top style clips used to attach screen to window opening.

L-5518

Diecast Clips

Contents: 6 clips with #4 x 3/8" Phillips pan head sheet metal screws.

Description: Lever style clip used to attach screen to window opening.

*Call for
Availability*

Window Screen Hardware

Plastic Clips

Contents: 12 clips with installation screws.

Color (Part Number)

Size	Gray	Black	White	Bronze
1/16" *	L-5507	L-5718	L-5721	L-5724
1/8" *	L-5679	L-5719	L-5722	L-5725
3/16" *	L-5508	L-5720	L-5723	L-5726
5/16" **	L-5509	L-5570	L-5573	L-5727
3/8" **	L-5510	L-5571	L-5574	L-5728
7/16" **	L-5511	L-5572	L-5575	L-5729

Description: Clips in various colors used to attach screen to window opening.

*No. 8 Phillips pan head **sheet metal screws**.

No. 10-24 Phillips pan head **machine screws.

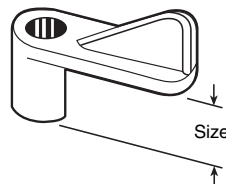

- L-5671** (5/16")
- L-5672** (3/8")
- L-5673** (7/16")

Plastic Clips (Gray)

Contents: 12 clips with #8 x 1" Phillips pan head sheet metal screws.

Description: Clips are supplied with **1" long screws** for **Hawaii** installations.



**Special
For Hawaii**

- L-5671**
- L-5672**
- L-5673**

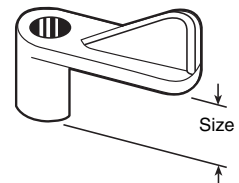

- L-5517** (White)
- L-5664** (Black)

Flush Clips (Plastic)

Contents: 12 clips with #6 x 5/8" Phillips pan head sheet metal screws.

Description: **Double wing** flush clips used to attach screens and storm windows to window opening.

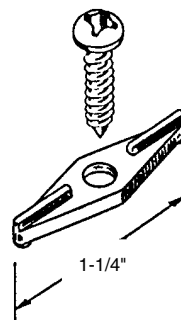

- L-5517**
- L-5664**

Flush Clips (Plastic)

Contents: 12 clips with #8 x 3/4" Phillips pan head sheet metal screws.

Color	Part Number
White	L-5506
Brown	L-5569
Black	L-5630
Gray	L-5680

Description: Clips are supplied with screws, used to attach screens and storm windows to window opening.

- L-5506**
- L-5569**
- L-5630**
- L-5680**

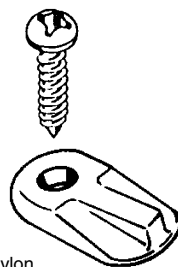

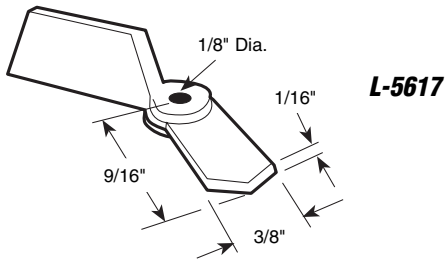

L-5617

Turn Buttons (White plastic)

Contents: 12 turn buttons with #4 x 3/4" Phillips pan head sheet metal screws.

Description: Turn buttons used to attach screens and storm windows to window opening.

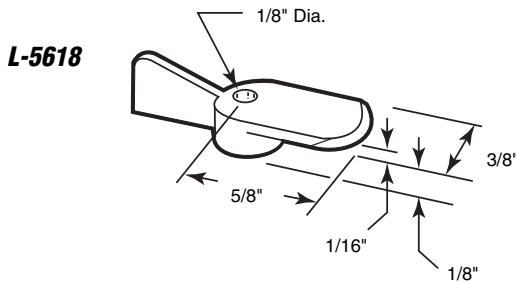

L-5618

Swivel Clips (White nylon)

Contents: 12 clips with #8 x 3/4" Phillips pan head sheet metal screws.

Description: Swivel clips used to attach screens and storm windows to window opening.

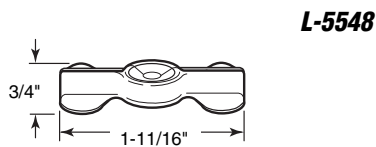

L-5548

Flush Clips

Contents: 6 clips with #8 x 1/2 flat head sheet metal screws.

Description: Nickel plated steel, double wing clips used to attach screens and storm windows to window opening; also applied to narrow rails to hold adjacent screens in place.

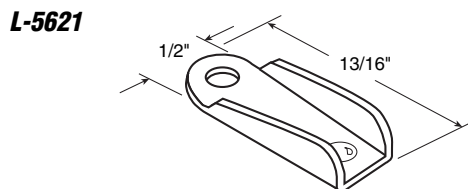

L-5621

Wing Clips

Contents: 12 clips with #8 x 3/4" Phillips pan head sheet metal screws.

Description: Stamped aluminum clips used to attach screens and storm windows to window opening.

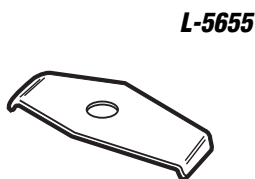

L-5655

Metal Clips

Contents: 12 clips with #8 x 3/4" Phillips pan head sheet metal screws.

Description: Stamped aluminum, double wing clips commonly applied to narrow rails on interior of double casement windows to hold adjacent screens in place.



L-5656

Metal Clips

Contents: 12 clips with #8 x 3/4" Phillips pan head sheet metal screws,

Description: Stamped aluminum clips used with L-5655 on casement window applications and other similar flush mount applications..

Window Screen Hardware

L-5706 (Black)
L-5707 (White)

Nylon Clips

Contents: 4 clips with #6 x 5/8" round washer head machine screws.

Description: Clips used to attach screens to **Acorn** windows.

L-5512 (5/16")
L-5513 (3/8")
L-5514 (7/16")
L-5515 (7/8")
L-5516 (1-3/16")

Casement Clips (Aluminum)

Contents: 12 clips with #10-24 Phillips pan head machine screws.

Description: Casement clips used to secure window screens and storm windows to window or storm door openings.

L-5519

Retainer Clips (Spring steel)

Contents: 6 clips.

Description: Retainer clips hold **3/8" screen frame** into aluminum window channel; **bright finish**.

L-5520

Retainer Clips (Spring steel)

Contents: 6 clips.

Description: Retainer clips hold **7/16" screen frame** to aluminum window channel; **bright finish**.

L-5521

Retainer Clips (Vinyl)

Contents: 6 clips.

Description: **Black vinyl** clips are used to hold **3/8" and 7/16" screen frame** into aluminum window channel.

L-5603

Retainer Clips (Vinyl)

Contents: 6 clips

Description: **Black vinyl** clips are used to hold **3/8" screen frame** into aluminum window channel; fits on **Tom Ray** windows.

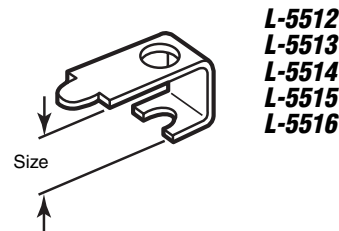
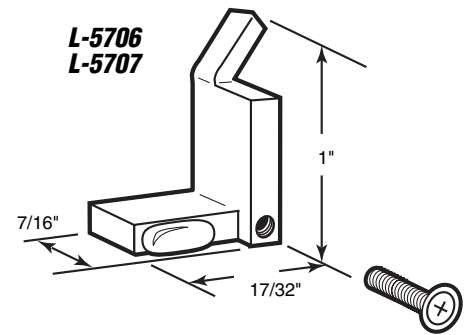

L-5519

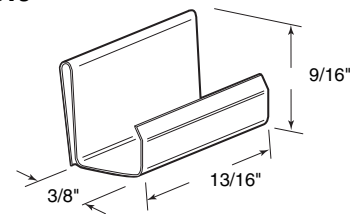

L-5520

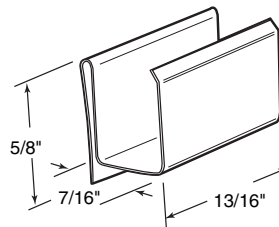

L-5521

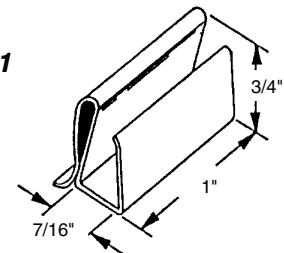

L-5603

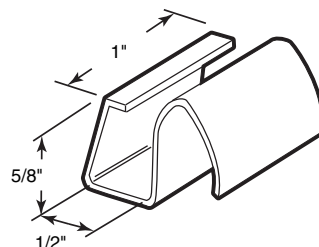

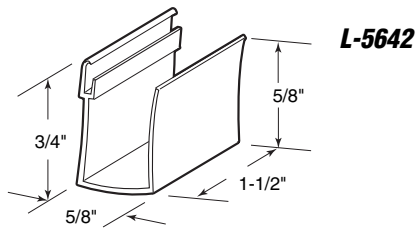

L-5642

Retainer Clips (Vinyl)

Contents: 6 clips.

Description: Black vinyl clips are used to hold screen frame into aluminum window channel; fits on "Old Style" *Better Built* windows.

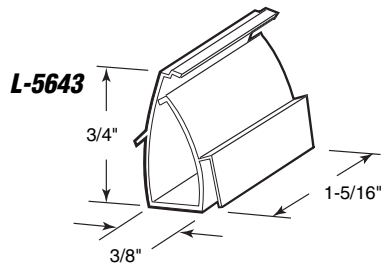

L-5643

Retainer Clips (Vinyl)

Contents: 6 clips.

Description: Black vinyl clips are used to hold screen frame into aluminum window channel; fits on "New Style" *Better Built* windows.

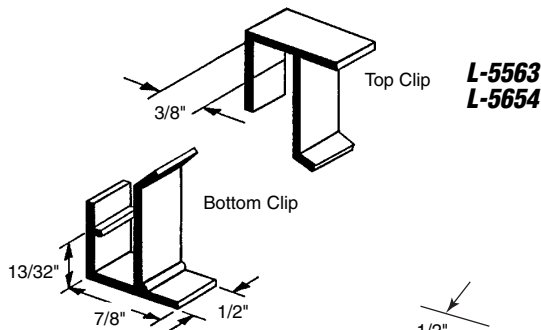

L-5563 (2 sets/card)

L-5654 (4 sets/card)

Retainer Clips (Vinyl)

Contents: 1 set = 1 top clip and 1 bottom clip.

Description: Black vinyl clips hold screen frame into sliding window frame channel; fits on *H&D Industries* for 7/16" frame. Very popular in the Northwest.

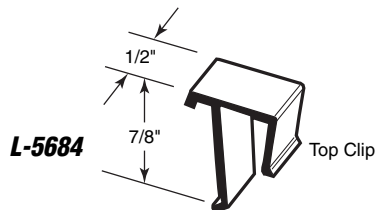

L-5684

Retainer Clips (Vinyl)

Contents: 4 top and 4 bottom clips.

Description: Black vinyl clips hold screen frame into sliding window frame channel; for 3/8" frame.

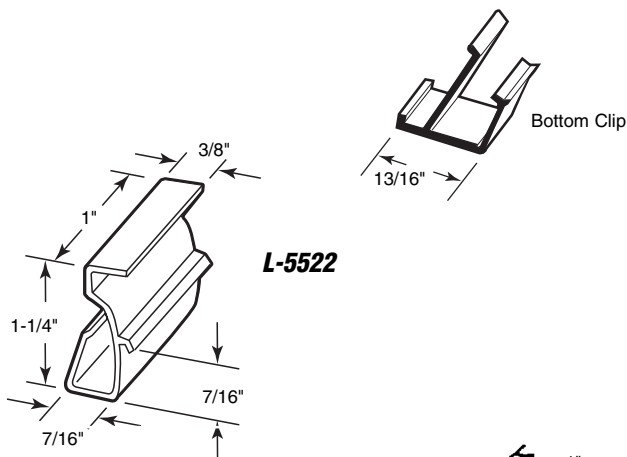

L-5522

Lift and Retainer Clips (Vinyl)

Contents: 6 clips

Description: Black vinyl clips used to hold 3/8" screen frame into aluminum window channel; lift tab assists in screen removal.

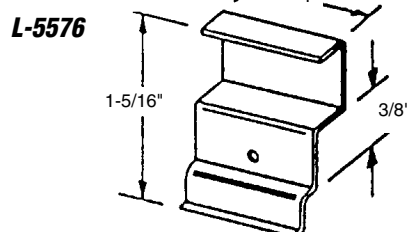

L-5576

Lift and Retainer Clips (Aluminum)

Contents: 6 clips with installation screws.

Description: Stamped aluminum clip used as a lift handle and screen frame retainer on sliding aluminum windows.

Window Screen Hardware

L-5523

Lift Tabs (Plastic)

Contents: 6 tabs.

Description: **Black vinyl** lift tabs used to aid in removal of **7/16" window screen** from window frame.

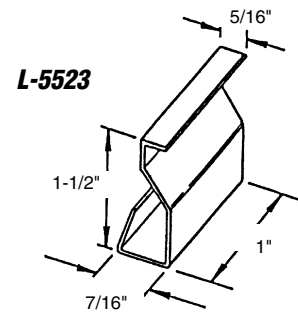

L-5524

Lift Tabs (Metal)

Contents: 6 tabs.

Description: **Stamped aluminum** lift tab is installed in spline channel to aid in removal of window screen from window frame.

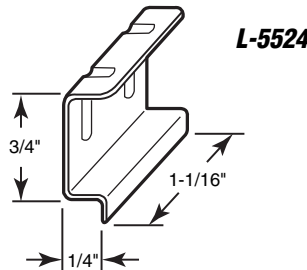

L-5525 (White)

L-5566 (Black)

L-5677 (Gray)

Lift Tabs (Plastic)

Contents: 6 tabs.

Description: **Plastic** lift tab is installed in spline channel to aid in removal of window screen from window frame.

L-5525 L-5566 L-5677

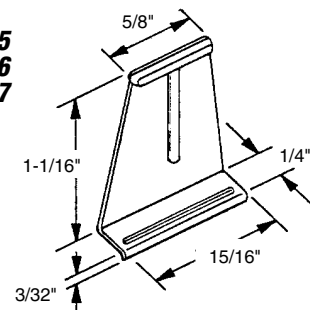

L-5685

Lift Tabs (Plastic)

Contents: 6 tabs.

Description: **Deluxe black plastic** lift tab is installed in spline channel to aid in removal of window screen from window frame.

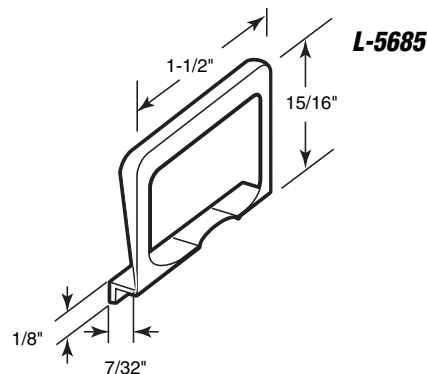

L-5686 (Gray)

L-5687 (Black)

Lift Tabs (Vinyl)

Contents: 6 tabs.

Description: **Vinyl** lift tab may be installed in most sizes of spline channel to aid in removal of window screen from window frame.

L-5686 L-5687

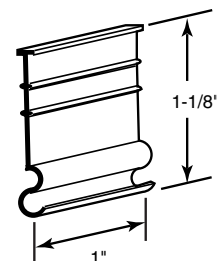

Stretcher Clips

Contents: 12 clips; 12 - #10 x 3/8" Phillips pan head sheet metal screws.

Part #	Frame Application
L-5578	3/8" x 5/8" flanged frame
L-5579	5/16" x 3/4" frame
L-5580	3/8" x 3/4" frame
L-5581	7/16" x 11/16" frame
L-5582*	For "Miami" Windows
L-5596	1/4" x 3/4" frame
L-5597	For flanged frame
L-5598	For "Keller" windows - old style
L-5599	For "Keller" windows - new style
L-5600	"Z" clips with 1/8" offset
L-5602	1/4" x 11/16" frame
L-5622	3/8" x 13/16" flanged frame
L-5678	For recessed frame
L-5682	3/8" x 5/8" frame

Description: Stamped aluminum clips for attaching window screens to awning and other types of windows.

*Installation screws are not required for this item.

L-5578

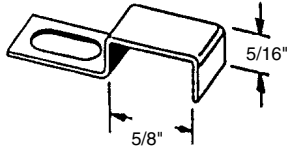

L-5579

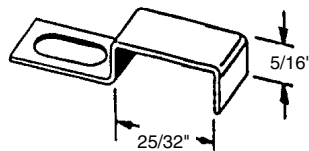

L-5580

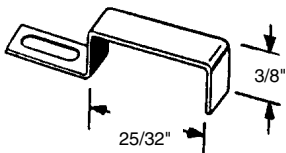

L-5581

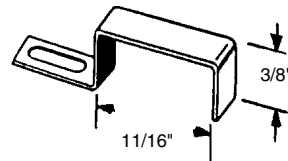

L-5582

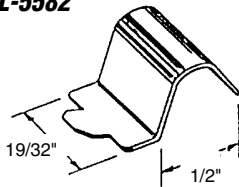

L-5596

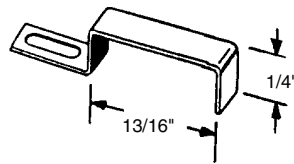

L-5597

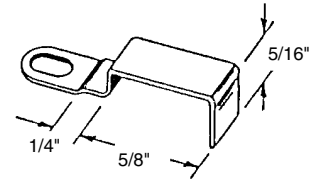

L-5598

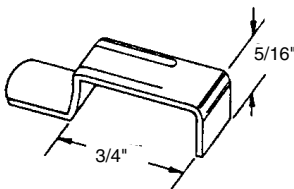

L-5599

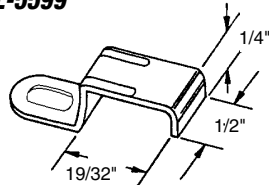

L-5600

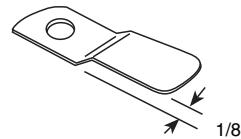

L-5602

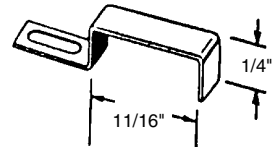

L-5622

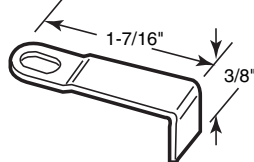

L-5678

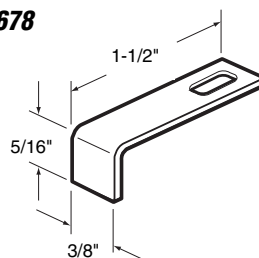

L-5682

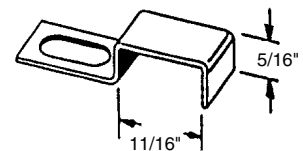

Plunger Latches

Contents: 6 latch assemblies.

Part #	Plunger	Cap	Screen Frame
L-5539	Nylon	Nylon	1/4" or 5/16" x 3/4"
L-5540	Nylon	Nylon	3/8" or 7/16" x 3/4"
L-5541	Diecast	Nylon	3/8" or 7/16" x 3/4"
L-5542	Diecast	Nylon	7/16" x 1"
L-5555	Aluminum	Aluminum	5/8"
L-5631	Aluminum	Aluminum	7/16" x 3/4"
L-5632	Aluminum	Aluminum	7/16" x 1"

Description: Spring loaded plunger latches hold aluminum frame screens into window frames.

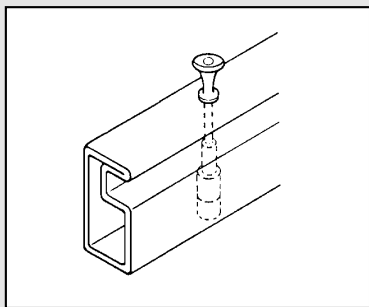

Note: For new installations, see **part no. L-5628** on **page L-12**. This **step drill** may be used for drilling screen frame for all plunger latches except **part no. L-5539**.

L-5536 (For 5/8" frame) - 3/32"

L-5537 (For 3/4" frame) - 1/8"

L-5538 (For 1" frame) - 1/8"

Lock Pins

Contents: 6 pins.

Description: Plated steel pin used to secure window screens to sliding aluminum windows.

L-5545 (1-1/2" long)

L-5559 (1-13/32" long)

Slide Locks

Contents: 6 locks.

Description: Stamped aluminum locks used to attach window screens to aluminum window channels.

L-5539

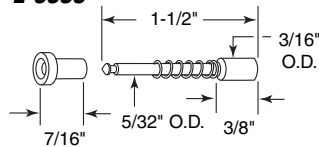

L-5540

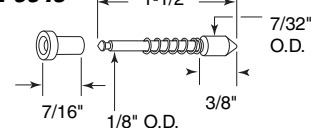

L-5541

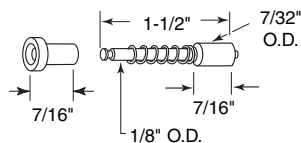

L-5542

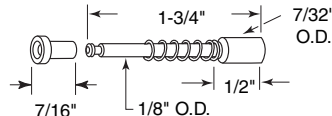

L-5555

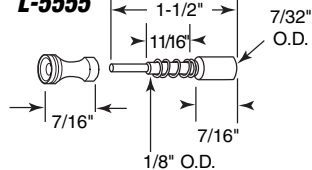

L-5631

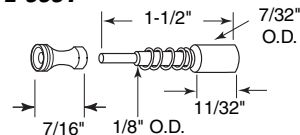

L-5632

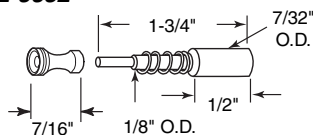

L-5536
L-5537
L-5538

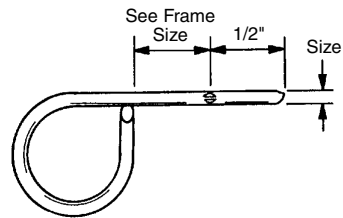

L-5545
L-5559

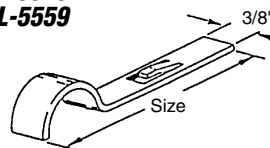

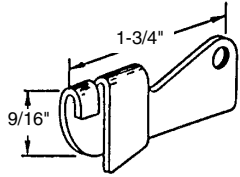
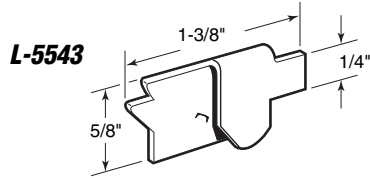

L-5544

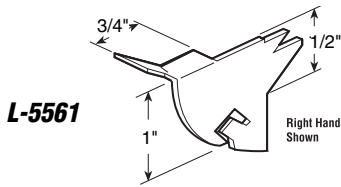

L-5561

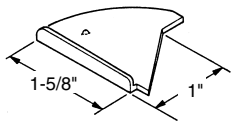

L-5562

L-5529
L-5551
CCEP-5529

1 Set Shown

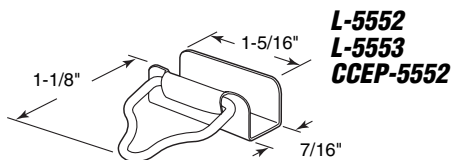
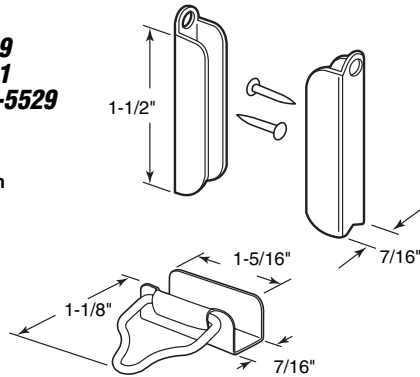

- L-5543** (Snap-on)
- L-5544** (Rivet-on)
- L-5561** (Swivel)
- L-5562** (Swivel)

Knife Latches

Contents: 3 left hand & 3 right hand latches.

Description: Stamped aluminum latches used to secure window screens to sliding aluminum window frames.

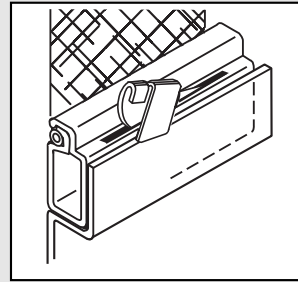

Clasp Latching

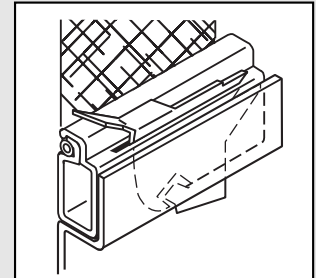

Slot Latching

- L-5529** (Mill finish)*
- L-5551** (Painted gray)

Hangers and Latches

Contents: 4 top hangers; 2 bottom latches; 2 ball head screws.

Description: Stamped aluminum hardware used to install 7/16" thick window screens to wood framed windows; the contents will accommodate installation of (2) window screens.

*Bulk: CCEP-5529 (2 sets/bag) 50 bags/box.

- L-5552** (Mill finish)*
- L-5553** (Painted gray)

Bottom Latches

Contents: 4 latches; 4 ball head screws.

Description: Stamped aluminum latches slip-on to bottom of 7/16" thick frame; used to hold bottom of window screen to wood window sill.

*Bulk: CCEP-5552 (4/bag) 100 bags/box.

Window Screen Hardware

L-5554

Spline Latch

Contents: 4 latches; 4 ball head screws.

Description: Stamped aluminum latch is installed into spline channel of window screen; used to hold bottom of screen to wood-framed window sill.

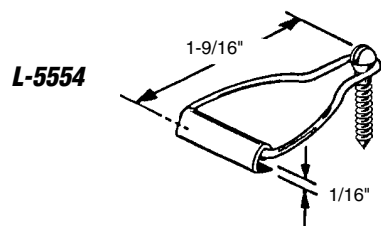

L-5560 (Aluminum)

L-5683 (White)

Top Hangers

Contents: 6 hangers; 6 nails.

Description: Stamped mill finish and white painted aluminum hangers nail into top corners of wood window frame; used to hold 7/16" thick screen frame to window frame and allow for easy removal.

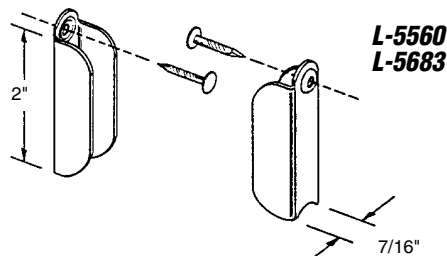

L-5567

Nail Set Tool

Contents: 1 tool.

Description: Plated steel tool used to install nails into wood framed windows using L-5529, L-5551, L-5560 hangers.

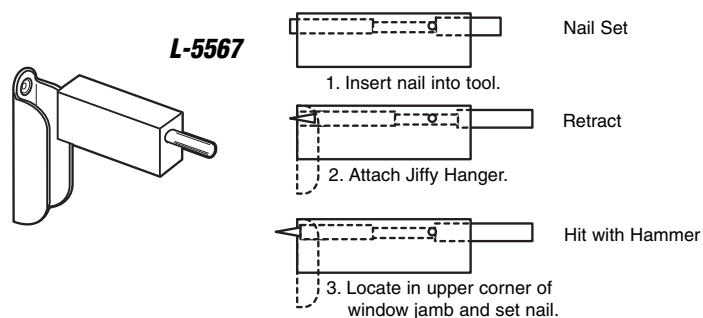

PL-14705 (100/tub)

PL-14706 (1000/tub)

Ball Head Screws

Contents: Bulk screws in plastic tub.

Description: Plated steel screws are used with bottom latches L-5552, L-5553 & L-5554 to hold window screen to wood window sill; no. 8 x 1" ball head screw.

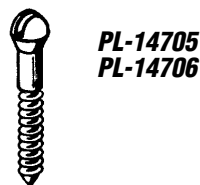

PL-14732

Self-Tapping Screws

Contents: 100 bulk screws in plastic tub.

Description: 10-24 x 3/4" Phillips pan head self-tapping machine screw; used to attach screen clips onto steel window frames.

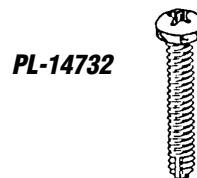

L-5623 (523)

L-5624 (524)

L-5625 (525)

L-5626 (1029)

Retainer Clips

Contents: 4 clips.

Description: Clear plastic clips; used exclusively in Western Canada to hold window screens to sliding window frames; use number molded into plastic part for exact replacement.

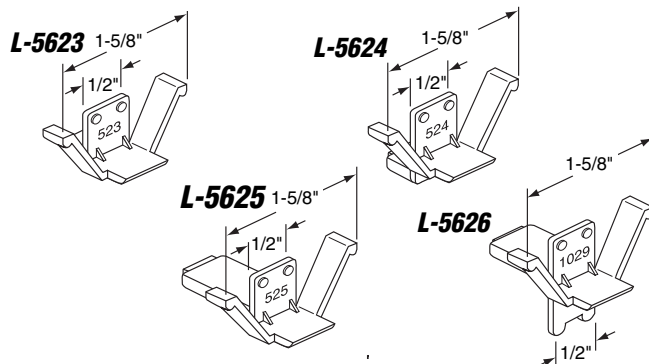

L-5532

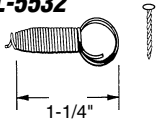

L-5658

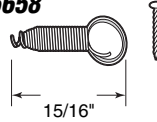

L-5659

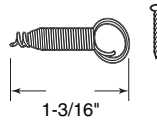

L-5660

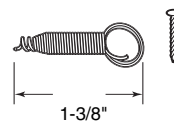

L-5534

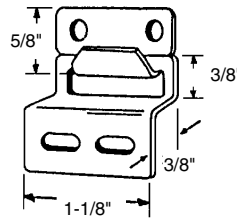

L-5661

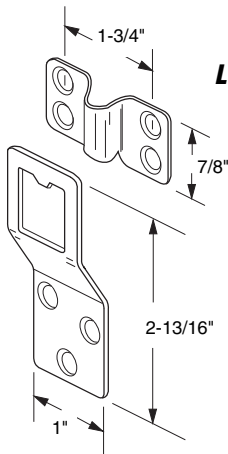

L-5568

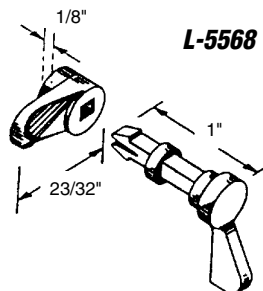

L-5527

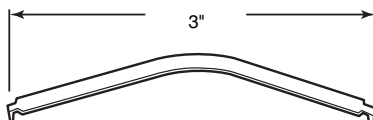

L-5629

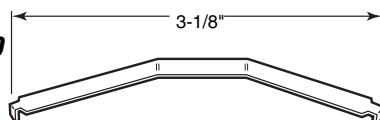

L-5532 (Plated steel)

L-5658 (Stainless steel)

L-5659 (Stainless steel)

L-5660 (Stainless steel)

Spring Latches

Contents: 6 springs; 6 nails.

Description: Spring steel latches are used to hold bottom of window screen to wood framed window sill. Aluminum nail is driven part-way into sill and spring loop is pulled over nail.

L-5534

Top Hangers

Contents: 4 hooks; 4 keepers; 4 sets of installation screws.

Description: Stamped aluminum hardware; used on wood framed windows; top mounted; hooks mount to window frame and keepers mount to screen frame.

L-5661

Top Hangers

Contents: 2 hooks; 2 keepers; 2 sets of installation screws.

Description: Plated steel hardware; used on wood framed windows; top mounted; hooks mount to window frame and keepers mount to screen frame.

L-5568

Retainer Clip Assemblies

Contents: 6 clips; 6 lock pins.

Description: Plastic assembly fits on Arcadia 770 and 780 Series windows; holds screen frame to window frame.

L-5527 (Round top)

L-5629 (Flat top)

Tension Springs

Contents: 6 springs.

Description: Heat-treated steel tension springs hold window screens into sliding aluminum window screen channels. Requires two (2) 3/16" holes drilled 3-3/16" apart.

Window Screen Hardware

L-5577 (1/4" wide)
L-5605 (3/16" wide)

Tension Springs

Contents: 6 springs.

Description: Heat-treated steel tension springs hold window screens into sliding aluminum window screen channels. Slips into corner of 3/8" or 7/16" frame. No tools required.

L-5528
L-5620 (Heavy Duty)

Tension Springs

Contents: 12 springs.

Description: Plated steel spring wire; designed to hold window screens into sliding aluminum window screen channels.

L-5535

Hook & Eye

Contents: 2 hooks; 2 eyes.

Description: Plated steel hook and eye; used as a bottom latch on traditional wood frame window screens.

L-5604

Clips

Contents: 4 clips.

Description: Stamped aluminum clips used for mounting window screens and storm panels to window frames.

L-5628

Step Drill

Contents: 1 drill.

Description: Specially designed step drill is used to install a variety of plunger latches (see page L-8).

You may also wish to stock these related parts: L-5539, L-5540, L-5541, L-5542, L-5555, L-5627.

L-5577
L-5605

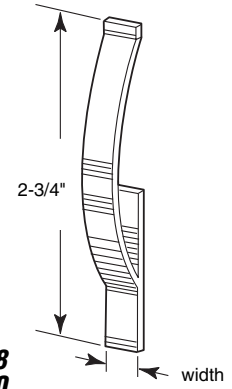

L-5528
L-5620

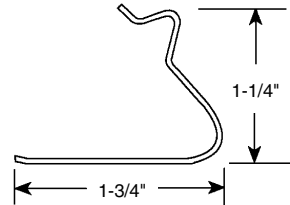

L-5535

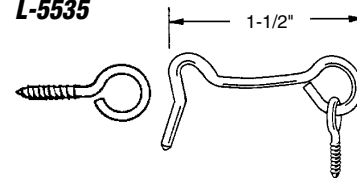

L-5604

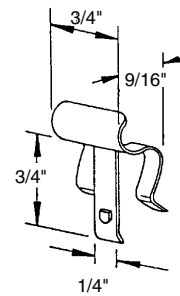

L-5628

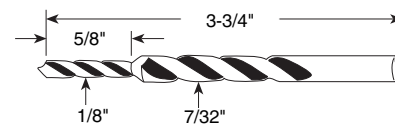

Also Available:

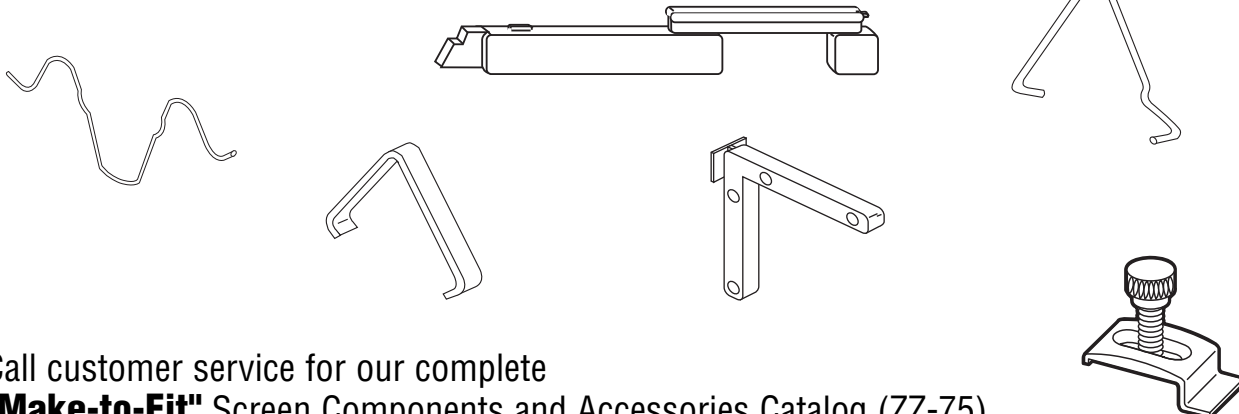

Call customer service for our complete
"Make-to-Fit" Screen Components and Accessories Catalog (ZZ-75).